



Manual

CCV
Edge IM15
Frame IM15



English

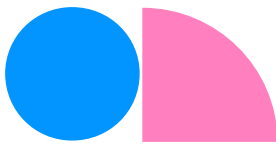

Introduction

Product introduction

The CCV Edge IM15 (front-mounted) and CCV Frame IM15 (flush-mounted) are unattended contactless payment terminals with a compact and robust design for small vending machines, electric charging stations, parking kiosks, etc..

The PIN-on-glass function prevents "can't pay" situations for consumers and with contactless payment, it provides a wide variety of payment methods around the globe.

With support for already established standard cut-outs, the IM15 can be installed in either landscape or portrait orientation and is perfectly fit for both indoor and outdoor use in all weather conditions.

The IM15 comes with LAN, Wi-Fi and Bluetooth built-in. A separate variant with 4G modem integrated is available as well for locations with limited connectivity infrastructure.

- Compact design with 3.5" LCD display
- Contactless payment support
- LAN, Wi-Fi and Bluetooth
- 4G LTE variant
- IP65 ingress protection and IK09 impact protection

About this document

This manual provides partners with information and support for the installation and use of the product. The product may exist in multiple variants and some functionality described in this manual may not apply to specific variants.

Throughout this document, the following level of warnings, cautions and notices is used:



WARNING: hazards or dangers that may result in personal injury or death



CAUTION: hazards that may damage the product



NOTICE: Provides additional advice or information on the described subject

Table of Contents

- 1. BEFORE YOU BEGIN 5**
 - 1.1 INSTALLATION PREPARATIONS 5
- 2. PRODUCT OVERVIEW 6**
 - 2.1 DIMENSIONS 6
 - 2.2 COMPONENTS 7
 - 2.3 PRODUCT VIEWS 8
- 3. UNPACKING AND ACCESSORIES10**
 - 3.1 WHAT’S IN THE BOX..... 10
 - 3.2 OPTIONAL ACCESSORIES 10
- 4. SETUP AND USAGE13**
 - 4.1 POWERING ON/OFF 13
 - 4.2 CONTACTLESS CARD-READER 13
 - 4.3 FRONT STATUS LED 13
 - 4.4 PROXIMITY SENSOR 14
 - 4.5 DEVICE STATUS LED..... 14
 - 4.6 RESET BUTTON 14
 - 4.7 SAM/SIM SLOTS..... 15
 - 4.8 DISPLAY 15
- 5. INSTALLATION16**
 - 5.1 CCV Edge IM15 16
 - 5.2 CCV FRAME IM15 16
 - 5.3 EVA EPS CDM CUT-OUT (LANDSCAPE OR PORTRAIT) 17
 - 5.4 EVA EPS SDM CUT-OUT 17
 - 5.5 CABLE CONNECTION INSIDE HOST MACHINE..... 18
- 6. CONNECTIVITY19**
 - 6.1 POWER & DIGITAL I/O 19
 - 6.2 RS-232 19
 - 6.3 LAN 20
 - 6.4 MDB 20
 - 6.5 USB TYPE-C (DEVICE) 21
 - 6.6 USB TYPE-A (HOST) 21
- 7. CONFIGURATION22**
 - 7.1 INITIAL DEVICE SETUP 22
- 8. PRODUCT LABELLING23**
- 9. IMPORTANT INFORMATION24**
 - 9.1 SAFETY INFORMATION 24
 - 9.2 ENVIRONMENTAL INFORMATION AND DECOMMISSIONING 26

9.3	CLEANING INSTRUCTIONS.....	26
9.4	REGULATORY COMPLIANCE	27
9.5	SYMBOLS EXPLANATION	28
10.	LEGAL DISCLAIMER	29
10.1	COPYRIGHT NOTICE.....	29
10.2	TRADEMARKS.....	29
11.	TECHNICAL SPECIFICATIONS.....	30
	CONTACT DETAILS	31

1. Before you begin

Before you begin with the installation of the product, make sure the following conditions and requirements are evaluated thoroughly.

1.1 Installation preparations

Install the payment device in a location/position so that the end-user can safely enter a secure PIN-code while blocking external views with hand or body. Also take the following conditions into consideration:

- Position the terminal between 80 cm and 120 cm from the ground. Only deviate from this specification if secure entry of the PIN is not possible.
- PIN-entry cannot be visible from a nearby elevated surface, through mirrors or cameras or any other way.
- The product has a virtual PIN-pad, which means the touch-screen is used for PIN-entry and other interactions. Take this into account in the positioning of the product.
- If necessary, an additional privacy shield may be required to provide secure PIN-entry.
- Make sure the product is installed following the environmental conditions specified. See Technical Specifications of the product for the allowed temperature and humidity conditions.
- Avoid installation where the product is subject to shocks and vibration, direct sunlight, dust, water or condensation or excessive electromagnetic interference.

2. Product overview

2.1 Dimensions

2.1.1 CCV Edge IM15

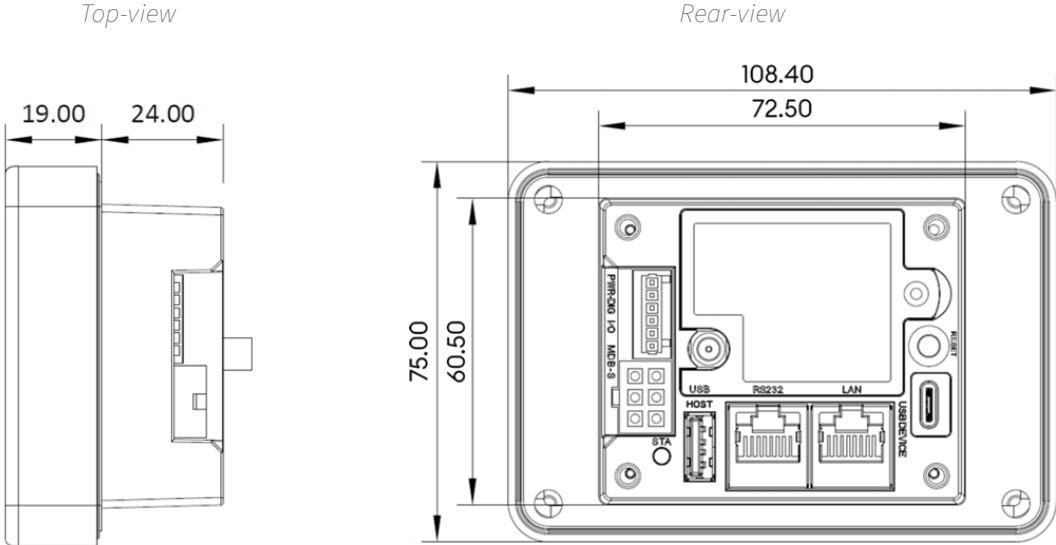

2.1.2 CCV Frame IM15

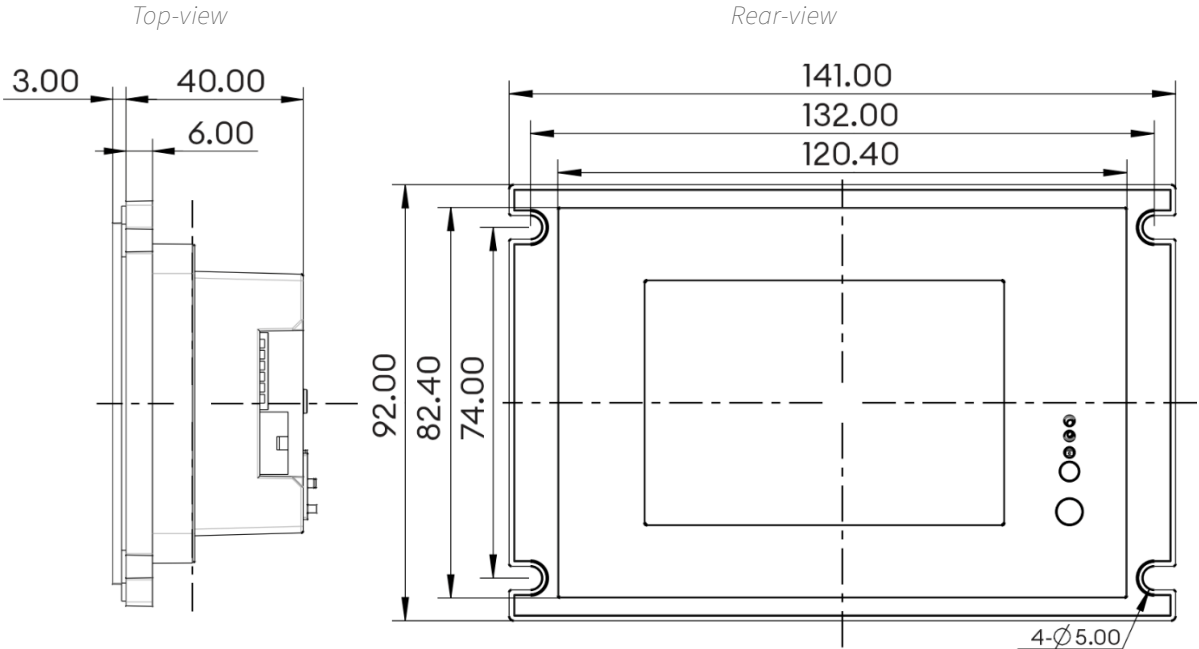

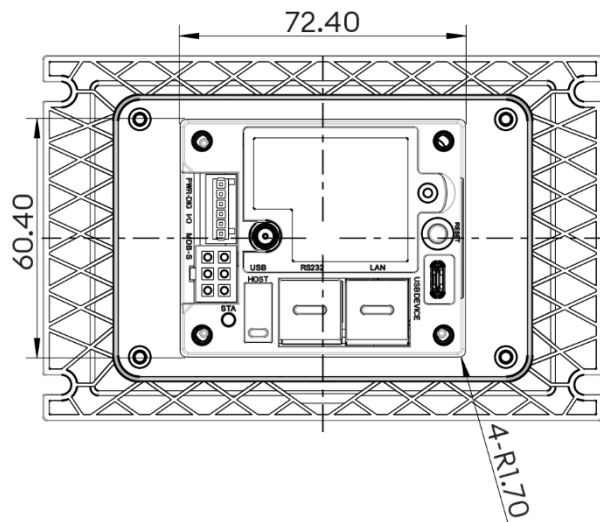

2.2 Components

Note: all components are the same for both CCV Edge IM15 and CCV Frame IM15.

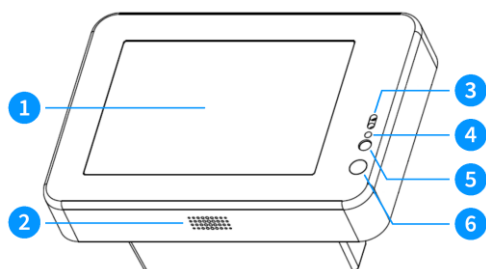

1. LCD touch-screen and NFC reader
2. Speaker
3. Proximity sensor
4. Front LED status indicator

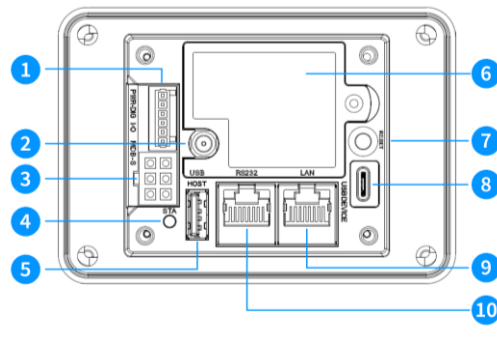

1. Digital I/O port and power connector
2. 4G antenna connector (LTE variants)
3. MDB port
4. Device status LED
5. USB-A port
6. Rear-cover
7. Reset button
8. USB-C port
9. RS-232 (RJ-45) port
10. LAN (RJ-45) port

2.3 Product views

2.3.1 CCV Edge IM15

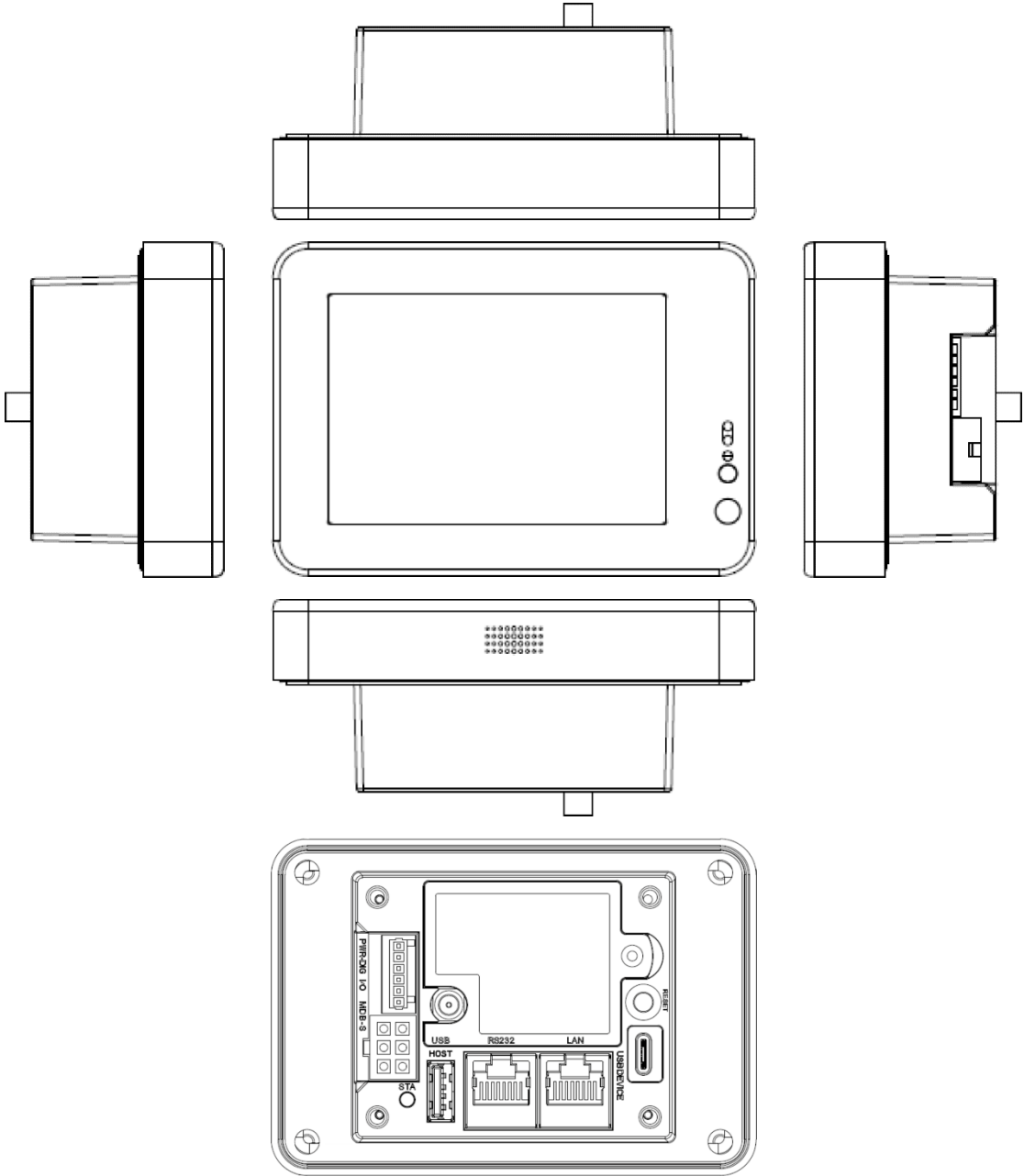

All side views

2.3.2 CCV Frame IM15

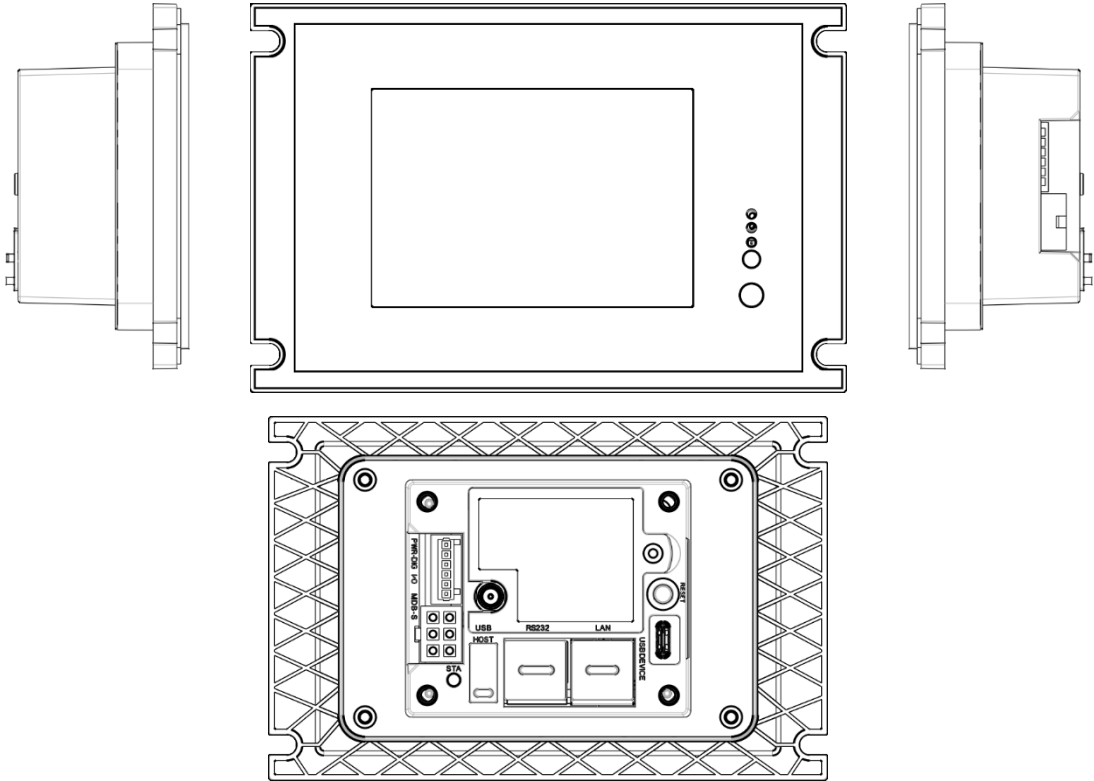





All side views

3. Unpacking and accessories

3.1 What's in the box

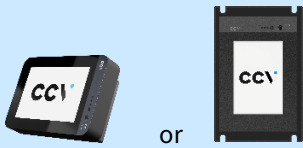





Each product is shipped with CCV's own product labels and a safety seal on the outside of the packaging. If your product labels or seals seem altered in any way or broken, please contact our helpdesk immediately to verify the shipment.

The product ships with the following items included:

Item	Qty	
Payment terminal IM15 (variant depending on order)	1	
M4 nuts for assembly of mounting frame	4	
M4 screws for assembly of the mounting frame to the product	4	
Metal mounting bracket (not included for CCV Frame IM15)	1	

3.2 Optional accessories

The following accessories can be purchased separately for this product. Contact your CCV sales representative for up-to-date list, order codes and pricing.

Item	
Universal power supply (For development/testing purposes only)	
Power adapter cable for IM15 (For use with universal power supply)	
LTE Dome antenna (Only for LTE variants)	
LTE model module (For adding LTE connectivity to non-LTE variants)	
MDB-Y cable	
Test cards (debit/credit)	
MDB wake up cable	

3.2.1 Dimensions LTE Dome Antenna (optional)

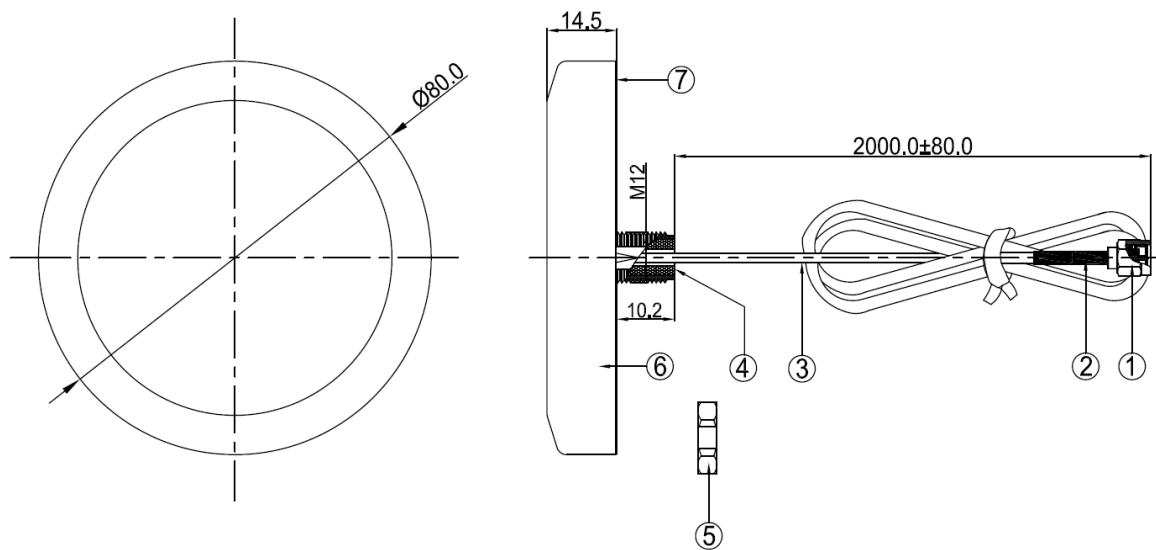

NOTICE: Antenna must be installed outside the machine housing for optimum signal reception.

No.	Part name	Description
1	SMA male	Cu Au plated
2	Hot shrink tube	L 25.0 mm / \varnothing 3.0 mm black
3	Cable	RG174 black low loss
4	Plastic plug	Plastic plug black
5	Nut	Cu Au plated
6	Antenna cap	\varnothing 80.0*14.0 mm black
7	PC black paster	\varnothing 79.6*0.2 mm

3.2.2 Dimensions MDB wake up cable (optional)

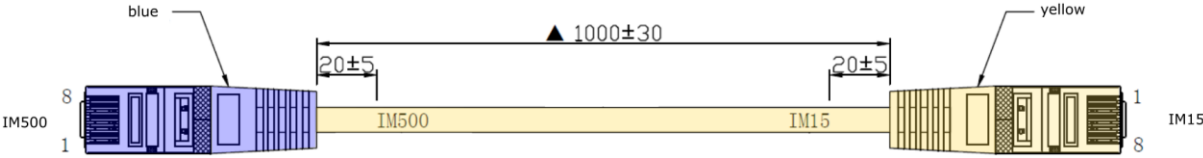

NOTICE: If MDB and power save mode are used, the optional cable is required to wake up the IM500! The blue plug must be connected to the IM500, the yellow plug to the RS232 of the IM15.

CCV PN 04174-16

4. Setup and usage

4.1 Powering on/off

The product can be powered through the following connections:

- Digital I/O & power connector
- MDB connector
- RS-232 (RJ-45) connector

Please see the technical specifications for accepted voltage levels and power consumption.

The device does not have a power button and will immediately power on/off when the power supply is connected/disconnected.



CAUTION: The power supply provided by CCV is for development purposes only. Field-installed products must be powered by a fixed power unit which complies with local regulations for electrical installations.

4.2 Contactless card-reader

The product has a contactless card reader built-in, located around the front display **1**. Whenever the device is ready to accept a contactless transaction, an indication will be shown on the screen of the device.

For best performance, position the contactless payment card in the centre of the front-screen at a distance of 0 to 4 cm.

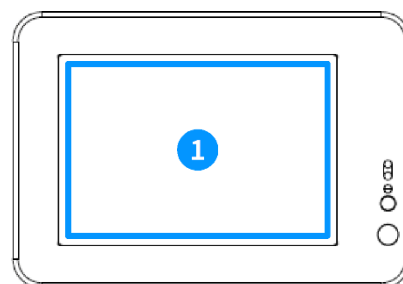

4.3 Front status LED

The front status LED indicator **4** is software controlled and will fade on/off when the device is in sleep mode.

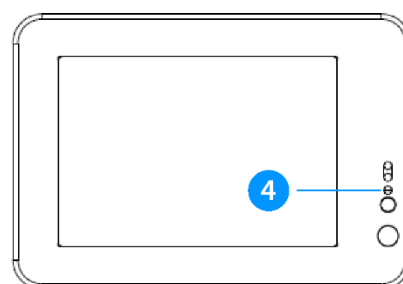

4.4 Proximity sensor

The front proximity sensor **5** detects objects at a close distance and provides a wake-up signal to the device.

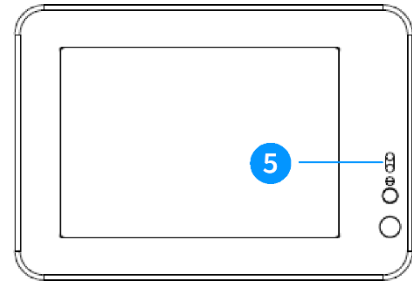

CAUTION: Remove the display protection film attached at delivery. It can cause unwanted triggering of the proximity sensor if it is not removed. This would prevent the screen saver, which may damage the display.

4.5 Device status LED

On the rear of the device, a status LED **6** provides information on the current state of the device.

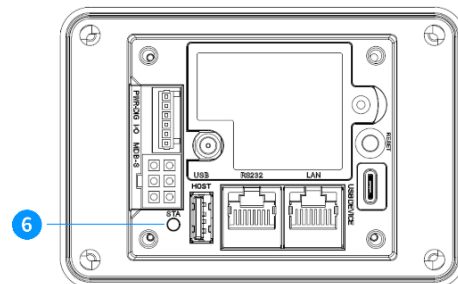

4.6 Reset button

On the rear of the device, a reset button **7** is available to perform a soft-reset of the device. This action will not erase any parameters or settings and can be used to reboot without disconnecting the power supply.

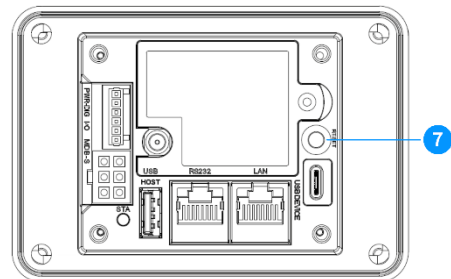

4.7 SAM/SIM slots



CAUTION: Always remove the power source of the device before opening the rear cover.

The CCV Edge/Frame IM15 comes with 2 micro-SAM-card slots (Secure Access Module) **8** for secure payment transactions. To access these slots, the rear cover (and 4G module in case of LTE variant) needs to be removed.

To install a SAM-card, open the card-slot and insert the card into the slot with the clipped corner of the card to the upper right, then lock the mount with the card inside.

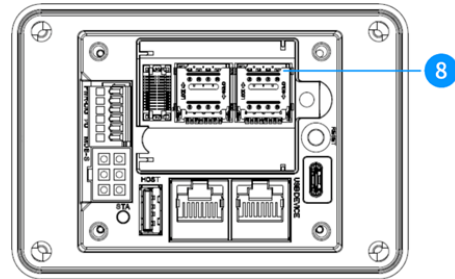

For variants with built-in 4G module, one SIM-card (Micro SIM 3FF) can be installed in the 4G module (board located underneath the rear-cover). After removal of the rear-cover, you can immediately access this slot. Unlock the card slot by sliding the clip down and insert the card into the slot with the SIM-card contacts facing towards the 4G module and with the clipped corner of the SIM-card to the left.

To reassemble the device, mount the back-cover and tighten the screw.

Note: Use SIM cards suitable for the required data volume. The device connects to the Network Service Provider (transactions) and CCV's Terminal Management System (software updates). Data usage depends on the environment where the product is installed. Typical data package sizes are:

- Software updates: up to 25 MB
- Transactions: estimated up to 2MB per month depending on volume
- Heart beats (assuming a daily heart beat): +/- 5 MB per month.

4.8 Display

The display is a 3.5" TFT LCD 480 x 320 pixel touch screen.



CAUTION: It is strongly advised to use a screensaver to avoid degrading effects, such as image retention or burn-in.

5. Installation

5.1 CCV Edge IM15

The product is designed to be installed on a vertical surface, using a mounting plate with 4 protruding M4 stud bolts. The device is shipped with a gasket to prevent intrusion of dirt and liquids between the device (external part) and the machine front door. Before installation, always inspect this gasket for damages.

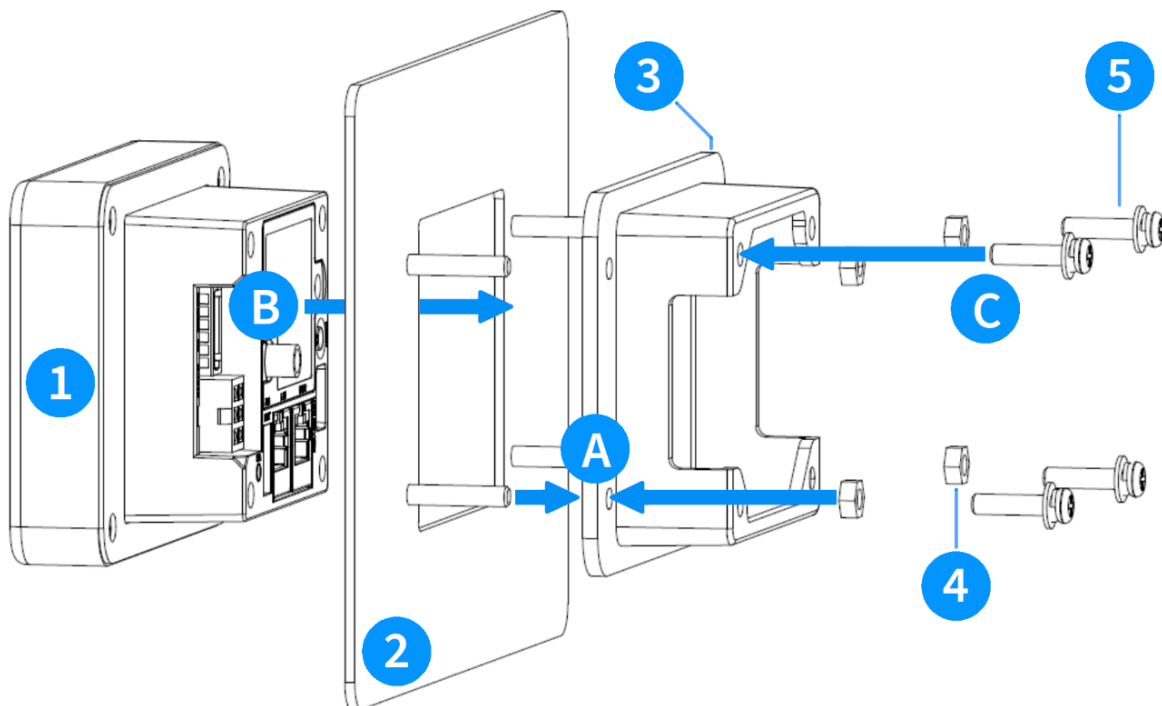

- A** Slide the mounting bracket **3** into place and fix with the four M4 nuts **4**
- B** Slide the IM15 **1** through the mounting plate/adaptor **2** into the mounting bracket **3**
- C** Secure the IM15 into the mounting frame with the four M4 screws **5**. Use a max torque of 0.8Nm +/- 0.2Nm for the M4 screws to avoid excessive pressure on the device as this may impact IP ratings of the terminal and the host machine.

5.2 CCV Frame IM15

5.3 EVA EPS CDM cut-out (landscape or portrait)

The product is compatible with the EVA EPS CDM (Compact Door Module) cut-out, as defined by the EVA (European Vending & Coffee Service Association) EPS (Electronic Payment Specification) standard for assembly in landscape or portrait orientation.

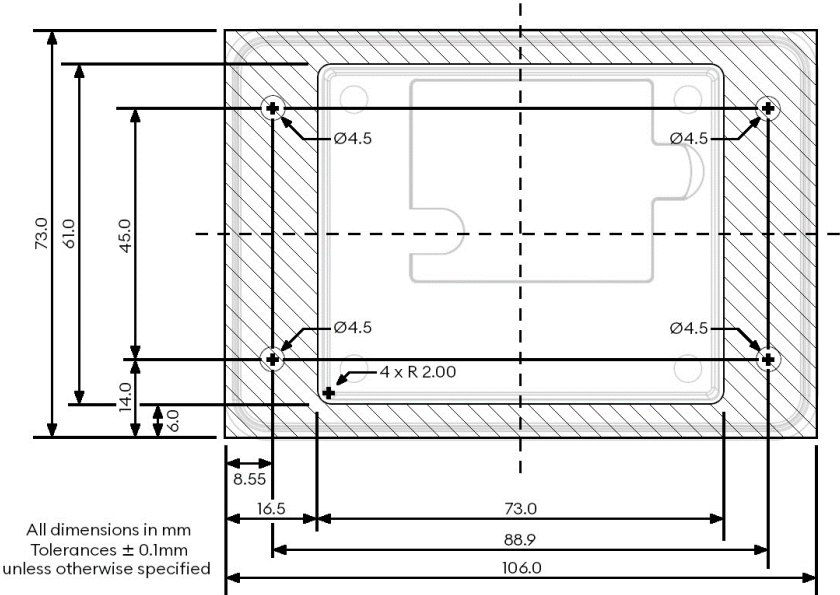

5.4 EVA EPS SDM cut-out

While it is also possible to install the CCV Edge IM15 using an EVA EPS SDM (Standard Door Module) cut-out, CCV does not provide an adapter frame for the product. Please consult the EVA standard documentation for required dimensions for such adapter plate.

The CCV Frame IM15 cannot be installed in the EVA EPS SDM cut-out.

5.5 Cable connection inside host machine



CAUTION: In order to protect the device from water entry, the cables must be attached in such a way, that liquids (i.e., condensation) cannot flow down the cable into the device:

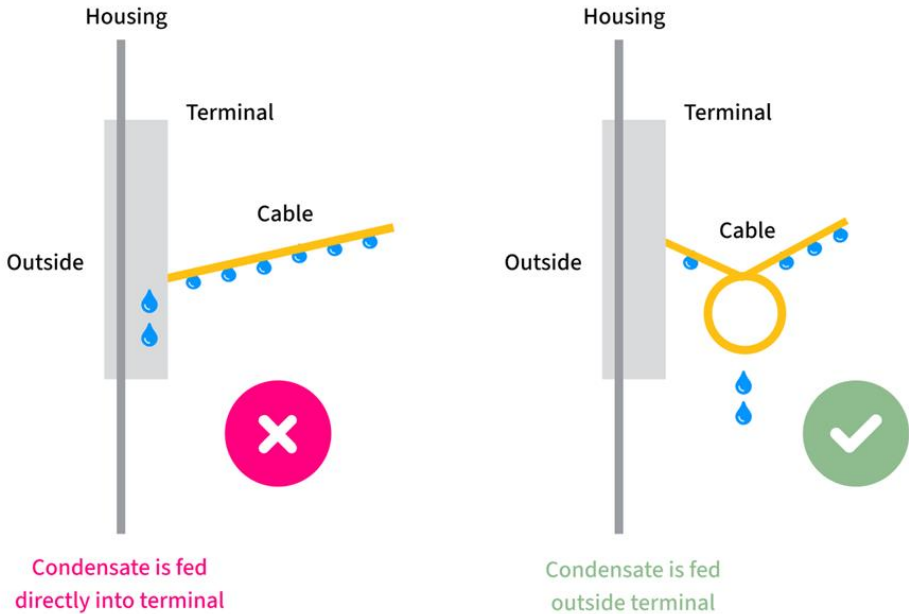

The occurrence of condensation moisture can be limited by avoiding rapid temperature and humidity condition changes or by avoiding direct flow of cold air onto the device.

6. Connectivity

All connections are located on the back of the product so they are protected against dirt or liquid intrusion when used in outdoor environments. Each connector is labelled individually and the removable rear cover of the device also contains an overview of the position of each connector.

6.1 Power & Digital I/O

The product can be powered by PWR-DIG I/O connector (6pin WAGO, plug 733-106). This connector also functions as a digital IO port.

Pin	Signal	Connector
1	DIGI_IN3	
2	DIGI_IN2	
3	DIGI_IN1	
4	DIGI_OUT1	
5	GND	
6	PWR	

6.2 RS-232

This connector can be used to connect accessories (such as card-readers) or connect to the device using serial communication.

Connector type: RJ-45, 8-poles (115.2 kbps), shielded, hardware handshake, max. cable length 100 cm.

Pin	Signal	Connector
1	POWER_IN	
2	RX	
3	TX	
4	MDB_WAKE	
5	RTS	
6	CTS	
7	GND	
8	GND	

6.3 LAN

The product has an Ethernet 10/100 Base-T port for LAN connectivity:

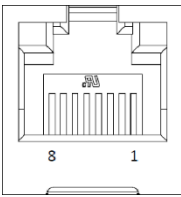
Pin	Signal	Connector
1	TX+	
2	TX-	
3	RX+	
4	NC	
5	NC	
6	RX-	
7	NC	
8	NC	

6.4 MDB

Multidrop Bus (MDB) is a communication protocol commonly used in the vending machines.

The product has a MDB port that can communicate to a vending machine controller as well as accept an input voltage of 9V to 42V.

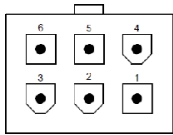
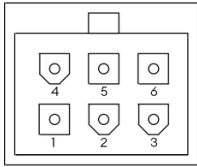
Pin	Signal	Connector
1	MDB PWR IN	<div style="display: flex; justify-content: space-around;"> <div style="text-align: center;">  <p>Connector on device</p> </div> <div style="text-align: center;">  <p>Connector on cable</p> </div> </div>
2	MDB PWR GND	
3	MDB-Wake Up	
4	MDB-Master Receive	
5	MDB-Master Transmit	
6	MDB-Com Common	

6.5 USB type-C (device)

The USB type C connector is used to connect the IM15 (as device) to a USB host:

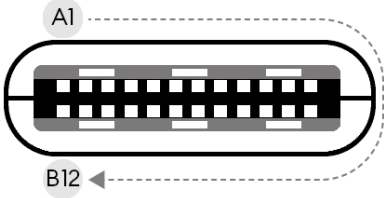
Pin	Signal	Pin	Signal	Connector
A1	GND	B1	GND	
A2	NC	B2	NC	
A3	NC	B3	NC	
A4	VBUS	B4	VBUS	
A5	NC	B5	NC	
A6	D+	B6	D+	
A7	D-	B7	D-	
A8	NC	B8	NC	
A9	VBUS	B9	VBUS	
A10	NC	B10	NC	
A11	NC	B11	NC	
A12	GND	B12	GND	

6.6 USB type-A (host)

The USB type A connector is used to connect the IM15 (as USB Host) to external USB devices (i.e. card-reader):

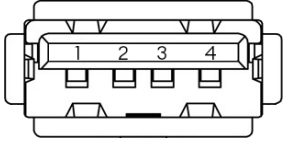
Pin	Signal	Connector
1	VCC	
2	Data -	
3	Data +	
4	Ground	

7. Configuration

This section describes the initial setup of the device and configuration of the device parameters:

7.1 Initial device setup

When the device is first started, an automatic setup procedure will start and the following settings can be configured:

7.1.1 Orientation

The product can be used in both landscape and portrait orientation. This setting can be changed again after the initial setup. The choice of orientation can have an impact on how content is shown on the screen so please align with your integration team on what the best orientation is for your use case.

7.1.2 Language

Select one of the available languages on the screen. The list of languages consists of multiple pages. Use the soft-buttons to scroll to the next/previous page if you don't see your language on the screen.

7.1.3 Terminal ID

This is a unique identifier for this specific terminal which is provided by CCV. It defines how a terminal behaves and makes sure transactions can be linked to a specific device. If you don't know your terminal ID, please reach out to CCV support.

7.1.4 Connectivity

Here you can choose how the terminal will connect to the payment backend. The terminal always needs to be connected, so please make sure you use a stable connection. Ethernet is the preferred connectivity method for stability.

7.1.5 DHCP

Dynamic Host Communication Protocol makes sure that the terminal automatically gets an IP address assigned to. If, for some reason, you need to use a static IP address, select no on this screen. To get an IP address assigned automatically, the Terminal must be connected to a router with an active DHCP server.

7.1.6 ECR connection

In this menu, the protocol for communication can be selected. Please make sure to align with your integration team on which protocol to choose in this screen. Once the protocol is selected, you will also need to enter the server and port to which the connection must be made.

8. Product labelling

The following product label template is used on the device:

IM15-XXX-XXX-XXXX
SN: 1234567890123456
MAC: XX:XX:XX:XX:XX:XX
SW: xx.xx.xx IM15.XX.XX.XX
SW-ID: xxxx
Key: IM15 XX



CCV **CE** 

CCV Edge IM15 12-48V,2.5A
Art.Nr: 12345-12





CCV **CE** 



CCV Plane IM15 12-48V,2.5A
Art.Nr: 12345-12





The following product label template is used on the packaging of the device:

CCV 
xxxxxxxxxxxxxxxx
CCV Edge IM15 **CE** 

Baugruppe Nr. xxxxx-xx zu Verkaufsartikel Nr:xxxxx-xx. BG besteht aus:
SN: xxxxxxxxxxxxxxxxxxxx ArtNr. 01234-25

MAC: 22:AA:44:BB:6C:8D HST-PN: IM15-XXX-XXX-XXXX
Key: XXXX HST-SN: IM15-XXX-XXX-XXXX
SW-ID: 1234 
Konfiguration: xx.xx.xx HSM-SN: XXXXXXXX
SW-Version: IM15.xx.xx.xx.xx 

9. Important information

9.1 Safety information

9.1.1 General

- Study and follow all instructions in this document before integrating or using the product as this contains important information. Keep this document for future reference.
- Damages or unexpected behaviour resulting from incorrect installation or operation may lead to rejection of warranty claims.
- No liability will be accepted for damage or injury resulting from incorrect installation, incorrect operation or from failure to observe and follow the safety guidelines.
- The product is certified for cashless payments in various countries, depending on the network service provider and acquirer. Please check the certifications for the country of installation before use.

9.1.2 Software updates

- The device must always be powered and connected to the Network Service Provider to receive software updates. In installations where remote maintenance is not possible, the integrator needs to perform on-site updates using certified service tools and additional costs may apply.
- Please obtain regular information about available and/or necessary updates or product extensions (through hotline of your network operator). Additional fees may apply.
- Following any changes or updates to the software, network infrastructure, or other changes to the product or connected devices, the complete payment process should be tested and validated.
- Only use software tools for interaction with the product which have been certified and provided by CCV (i.e. Terminal Supervisor) and make sure these are regularly updated. Latest versions are available from the CCV download server (<https://download.ccv-deutschland.de>).

9.1.3 Connection to power and external devices

- This device is designed for continuous operation and must be powered from a fixed power supply. The external power supply and power cord supplied by CCV is for testing and development purposes only and should not be used for field-installations.
- Do not remove the power supply while the device is performing a payment or other active functions (i.e. display indication „please wait...“). Please contact your network provider if such a message appears for a longer period.
- The device and users must be protected against ESD and EMC events by appropriate measures, such as grounding or shielding to prevent ESD from reaching users or sensitive components. The device is certified for contactless transactions (i.e. mobile phone with NFC interface).
- Make sure to provide only voltages at the connection pins of the product as indicated in this document.

9.1.4 Electrical shock or fire hazards

- Integration of the product may only be carried out by qualified specialists (i.e. electrician), according to the relevant regulations applicable at the place of installation and use of the product (i.e. VDE, CE).
- Unauthorized opening of the product leads to activation of the fraud detection mechanism and deletion of all secure data. This will prevent further use of the product and voids the warranty.
- Never submerge the product in water, throw into fire or expose to humidity or heat levels outside of the product specifications. The device should be cleaned with a soft damp cloth. Do not use chemical cleaners and take into account the ingress protection rating (i.e. IP65, IP34) of the product.
- The rear side of the device, which houses all connections, must always be kept away from dust and liquids.
- If cabling gets damaged, do not use the product and immediately repair or replace the affected cabling.
- Do not insert unknown materials into any port on the product as this may compromise the functionality, safety and security of the device.

9.1.5 Maintenance and warranty services

- Regular updates may be required for this product. Not carrying out these updates may lead to loss of approval and/or malfunction. Necessary updates are communicated by the supplier of the product or the Network Service Provider through release notes. CCV is not liable for malfunctions or damage resulting from lack of or incorrect maintenance by the user.
- The product is designed for outdoor use but it is strongly recommended to install the product with protection for dirt and possible liquids contaminants, and at regular intervals clean the product. Dust and liquids may result in fire.
- The performance of the built-in LCD panel may degrade when static visual information is shown. It is strongly advised to use a screensaver or dynamic content to avoid degrading effects, such as image retention or burn-in.
- Repair activities may only be performed by the device manufacturer or authorized service centres. Damage to or removal of the identification labels and seals on the equipment will immediately void the warranty.
- To extend/upgrade the warranty of the product, please contact your CCV sales representative for available maintenance contract options.
- When the product is no longer used, please dispose of it in an environmentally proper manner by handing it over to a designated collection point for recycling of product. Contact your local city office for applicable municipal waste disposal services.

9.1.6 Malfunctions

- CCV provides support during the initial integration of the product and recommends a joint-check of your product integration on-site prior to piloting to avoid/prevent malfunctions. Please contact your reseller or CCV directly for details on this.
- If you want to reset or change parameters on the product, please make sure that all transactions have been transferred to your payment provider through an end of day closure.

- The device contains tamper-proofing features. These circuits will trigger if the device is disassembled or subjected to heavy shock, at which point it will have to be rearmed by CCV before the device is ready to resume normal operation.
- In case of malfunctions, check the integrity of the device. Check if the product shows visual damage or manipulation. In case of damage, tampering or a broken seal, do not operate the product and immediately contact your payment provider or CCV for assistance.

9.2 Environmental information and decommissioning

9.2.1 Disposal information



Waste Electrical and Electronic Equipment (WEEE)

The symbol indicates that, under the European Directive 2012/19/EU governing waste from electrical and electronic equipment, the product should not be discarded as unsorted waste but must be sent to separate collection facilities for recovery and recycling. The WEEE marking must appear on any electrical and electronic equipment placed on the EU market.

When the product is no needed or has become obsolete/unusable, it can be decommissioned in an environmentally friendly manner and appropriate security measures must be taken prior to re-purposing/disposal (i.e., removal/decommissioning of SAM/SIM cards inside the product).

9.2.2 RoHS

Directive 2011/65/EC (RoHS 2) on the restriction of certain hazardous substances in electrical and electronic equipment. RoHS 2 compliance is indicated by the CE marking on the product.

According to the information declared by our component suppliers, this product is RoHS compliant.

9.3 Cleaning instructions

The product is designed for outdoor use, but it is strongly recommended to install the product with protection for dirt and possible liquids contaminants, and at regular intervals clean the product. Dust and liquids may result in fire.



CAUTION: The product should be cleaned with a soft damp cloth without the use of chemical cleaners. The use of chemical cleaners may impact the readability of the screen.

The product uses a lens for reading barcodes. It is advised to clean this lens at regular intervals to maintain a good reading performance.

If applicable, card-readers (internal or external) should be cleaned at regular intervals, depending on the usage and environmental conditions. This can be done by using standard dry cleaning cards and the device does not need dismantling for this process. The following recommendation applies for cleaning intervals of card-readers:

Frequency of use	Indoor	Outdoor (normal environment)	Outdoor (dirty/aggressive environment)
Up to 5x/month	Quarterly	Monthly	Weekly

Up to 5x/week	Quarterly	Monthly	Weekly
Up to 5x/day	Quarterly	Monthly	Weekly
Over 5x/day	Monthly	Monthly	Weekly

9.4 Regulatory compliance

9.4.1 Intended usage environment

The product is intended to perform payment transactions for merchants in unattended indoor and outdoor environments, such as but not limited to: electric charging stations, parking areas, vending machines, etc.

9.4.2 Manufacturing location and responsible party

Manufacturer: PAX Computer Technology (Shenzhen) Co. Ltd.

Responsible party: CCV GmbH

Address: Gewerbering 1, 84072 Au in der Hallertau, Germany

Tel: +49 8752 864 0

Website: www.ccv.eu

9.4.3 CE Declaration of Conformity

CCV hereby declares the accordance of the radio equipment CCV Edge/Frame IM15 to the directive 2014/53/EU. The complete texts of the EU declarations of conformity are available here:

<https://www.ccv.eu/en/support/documentation>

9.4.4 UKCA compliance

This device is in conformity with the essential requirements of 6(1) (a) the protection of health, safety and property, 6(1) (b) an adequate level of electromagnetic compatibility and 6(2) the efficient use of radio spectrum of the Radio Equipment Regulations 2017.

9.4.5 FCC compliance statement

Information regarding FCC compliance are available here:

<https://fccid.io/V5PIM15>

9.4.6 Industry Canada (IC) compliance statement

This device contains licence-exempt transmitter(s)/receiver(s) that comply with Innovation, Science and Economic Development Canada's licence-exempt RSS(s). Operation is subject to the following two conditions:

- This device may not cause interference,
- This device must accept any interference, including interference that may cause undesired operation of the device.









This device and its antenna(s) must not be co-located or operating in conjunction with any other antenna or transmitter, except tested built-in radios.

IC Radiation Exposure Statement

This equipment complies with IC radiation exposure limits set forth for an uncontrolled environment. This equipment should be installed and operated with a minimum distance of 20 cm between the radiator, including antenna, and your body.

9.5 Symbols explanation

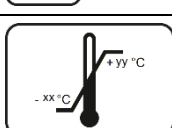
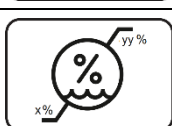
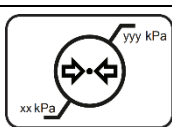
The following symbols may appear on the device, its accessories, its packaging or documentation. This is a non-restrictive list.

	The product meets all requirements of applicable EC directives and regulations.
	The product meets all requirements of applicable FCC directives and regulations.
	The product meets all requirements of applicable UKCA directives and regulations.
	The product is fragile and must be handled with care to prevent it from breaking or getting damaged.
	The product and its packaging must be protected against moisture during storage and transport.
	The box must be transported, handled and stored in such a way that the arrows always point upwards.
	Range of temperature conditions in which the product can be safely stored.
	Range of humidity pressure to which the product can be safely exposed during storage.
	Range of atmospheric pressure to which the product can be safely exposed during storage.
	The product must be disposed of according to the European Waste Electrical and Electronic Equipment (WEEE) directive and not be thrown in the trash.
	See Instructions for use for more information.

10. Legal disclaimer

Although CCV has made every attempt to provide technical accuracy in its documentation, we assume no responsibility for errors that could be found and the product specifications are subject to change without notice. If you discover any errors, inconsistencies or have feedback to improve our documentation, please let us know.

10.1 Copyright notice

This document is copyrighted. All rights are reserved. Neither this document, nor any part of it, may be reproduced or copied in any form or by any means - graphical, electronic, or mechanical including photocopying, taping or information storage and retrieval systems - without written permission of CCV.

© CCV GmbH – All rights reserved – Subject to modifications

10.2 Trademarks

All (registered) trademarks are property of their respective owners.

11. Technical specifications

Display	3.5" TFT LCD 480 x 320 Touch Screen 600 nits Supports PIN on Glass front-glass hardness 6 Mohs
Card Readers	Contactless
Scanner	Reads 1D & 2D codes
Memory	512 MB Flash + 512 MB DDR RAM
Keys / buttons	1 x Reset key (rear)
Audio	1 Speaker (side)
Dimensions	CCV Edge IM15 108,4 x 75 x 43mm (W x H x D), 108,4 x 75 x 18,5mm (W x H x D) outside the machine, 72 x 60 x 24,5mm (W x H x D) within the machine (without cables and mounting accessories) CCV Frame IM15 141 x 92 x 49mm (W x H x D), 141 x 92 x 46mm (W x H x D) within the machine (without cables and mounting accessories)
Front Frame cut-out	CCV Edge IM15 73 x 61mm, EVA EPS CDM compliant CCV Frame IM15 CCV cut-out compatible with OPP-C60c product
Connectivity	1 x USB Host (USB-A) 1 x USB Device (USB-C) 1 x LAN 1 x RS232 1 x MDB WiFi 5 GHz Bluetooth 5.0 4G RF Modem (optional)
Power supply	7 - 48 VDC via main power supply, MDB, or RS232
Power consumption (typ.)	Without 4G modem @ 12 VDC: max 500 mA 75 mA standby 7.4 mA sleep With 4G modem @ 12 VDC: max 1.5 A 100 mA standby 9.75 mA sleep
Security	2x Secure Access Module (SAM) slots
Environmental	-20°C ~ 70°C (-4°F ~ 158°F) Operating Temperature -30°C ~ 70°C (-22°F ~ 158°F) Storage Temperature 5% ~ 95% Relative Humidity, Non-Condensing IP 65 front casing IP34 reverse side IK09
Flammability rating	V2 according to UL94, IEC 60695-11-10, -20 and IEC 60950-1
Certifications	Payment: EMV Contactless L1 Mastercard PayPass L2 Visa payWave L2 American ExpressPay L2 Discover D-PAS L2 Interac_Flash L2 J/Speedy L2 Mastercard TQM qPBOC L1 qUICS L2 DK TA 7.2 Security: PCI PTS 6.x, SRED CSEC UKCC DC POS 3.0 Regulatory: FCC IC UL RoHS CE UKCA

Contact details

CCV GmbH

Gewerbering 1
84072 Au in der Hallertau

 +49 8752 864 444

 hotline@ccv.eu

www.ccv.eu



www.ccv.eu

© 2024, CCV GmbH. All rights reserved. No parts of this publication may be reproduced, stored in a retrieval system, or transmitted in any form by any means, electronic, mechanical, photocopying, recording or otherwise, without the written permission of CCV GmbH

Version: 05

Year: 2024